

# NEO·GEO<sup>®</sup>

SERVICE  
MANUAL

## MV2F / MV4F

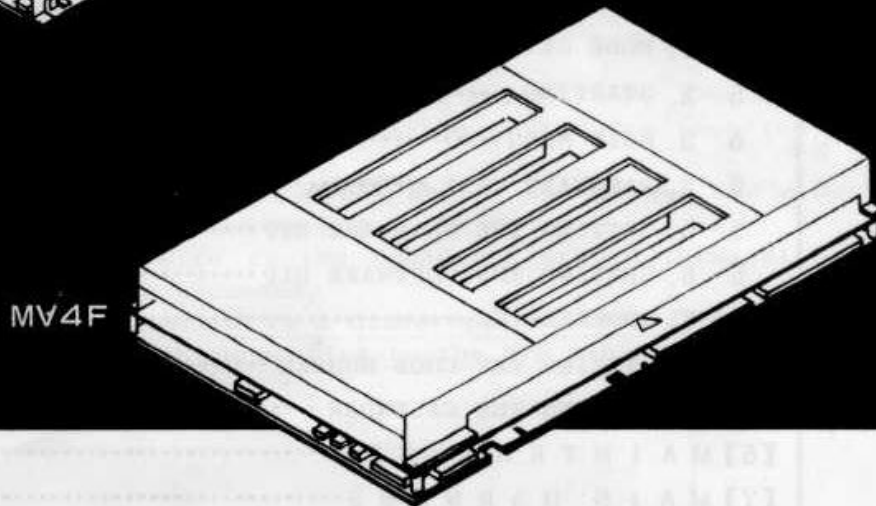
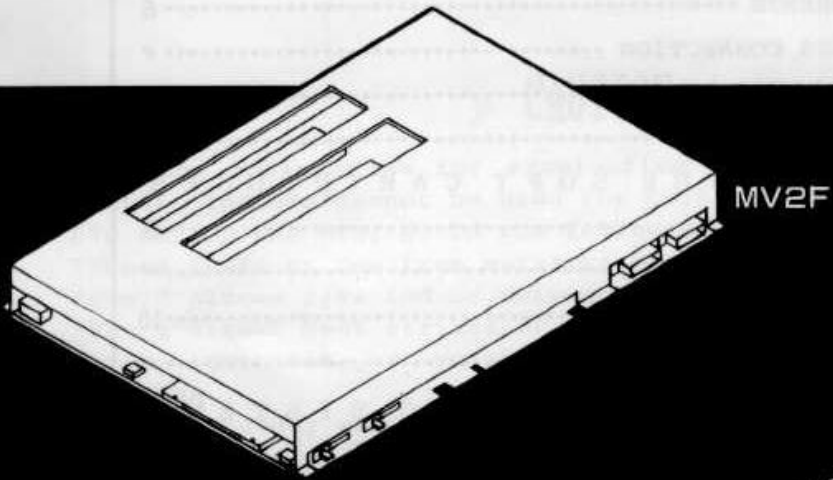

# SNK

# C O N T E N T S

INTRODUCTION .....	2
CAUTION .....	"
<b>【1】 M V - 2</b>	
1-1. COMPONENTS .....	3
1-2. HARNESS CONNECTION .....	"
1-3. ASSEMBLY .....	4
1-4. WIRING DIAGRAM .....	5
<b>【2】 M V - 4</b>	
2-1. COMPONENTS .....	6
2-2. HARNESS CONNECTION .....	"
2-3. ASSEMBLY .....	7
2-4. WIRING DIAGRAM .....	8
<b>【3】 S E T T I N G   T H E   S O F T   C A R T R I D G E S</b>	
3-1. BEFORE SETTING .....	9
3-2. SETTING CARTRIDGES .....	"
3-3. POWER ON .....	10
3-4. UNUSED SLOTS .....	"
<b>【4】 I N C O M E   D A T A   K E E P I N G   S Y S T E M</b>	
<b>【5】 T E S T   M O D E</b>	
5-1. MODE SETTING .....	12
5-2. STARTING .....	"
5-3. MAIN MENU .....	"
5-4. HARDWARE TEST .....	13
5-5. SETTING THE HARDWARE DIP .....	15
5-6. SETTING THE SOFTWARE DIP .....	16
5-7. BOOKKEEPING .....	17
5-8. SETTING THE CODE NUMBER .....	19
5-9. SETTING THE CALENDAR .....	"
<b>【6】 M A I N T E N A N C E</b> .....	20
<b>【7】 M A I N   H A R N E S S</b> .....	21

1-3 ASSEMBLY

S-V M [1]

## INTRODUCTION

Welcome to the NEO-GEO MULTI VIDEO SYSTEM. This system can hold two (MV-2) or four (MV-4) different NEO-GEO games in one cabinet, which enables you to save space and maximize your income. Only one compact set of P.C. boards with 2/4 slots for different games are required in one cabinet. The game cartridges can be easily inserted or removed from the slots. This is one of the remarkable advantages of our MVS.

Please read this service manual carefully before starting to use the MVS and keep it at your side for further reference.

## CAUTION

- ◇ Use the logic probe for examination of the circuit on the IC boards. Testers cannot be used for this purpose.
- ◇ To set up the MVS, avoid the following places:
  - \* Where leaks or dew from moisture may be caused
  - \* Humid places like indoor swimming pools and showers
  - \* Where direct heat strikes or in the hot air
  - \* Near ignitable or volatile chemicals and other dangerous articles
  - \* Near emergency exits or fire extinguishers
  - \* Inclined places or near vibrating places
  - \* Dusty places
- ◇ Keep the temperature between 5°C and 40°C.
- ◇ Do not put heavy objects on top of the PCBs.
- ◇ Do not transport the cabinet with the cartridges inserted in the main PCB.
- ◇ Use AC95V to AC105V for the power supply and do not use other devices from the same power source.
- ◇ Connect the ground wire to the cabinet's ground terminal and the cabinet should be grounded.
- ◇ The 56 pin main connector is a different one from JAMMA 56 pin and should be used with connection to the MVS cabinet.

# [1] MV - 2

## 1-1. COMPONENTS

MVS consists of 2 P.C. boards.

MV2.....Main programming, character display

MV-LED...Credit indicator

## 1-2. HARNESS CONNECTION

CREDIT DISPLAY PCB  
(7 SEGMENT)

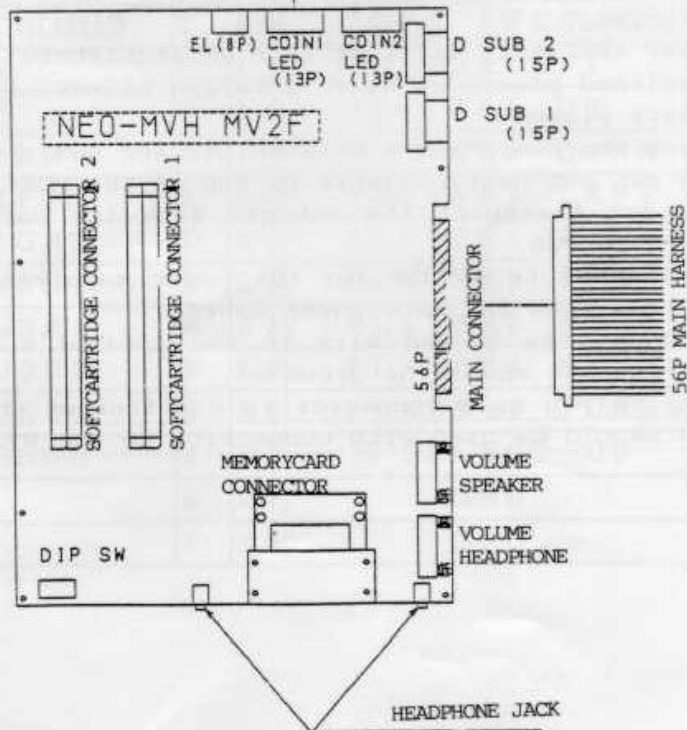
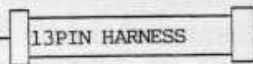
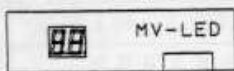

# 1-3. ASSEMBLY

1-4. WIRING DIAGRAM

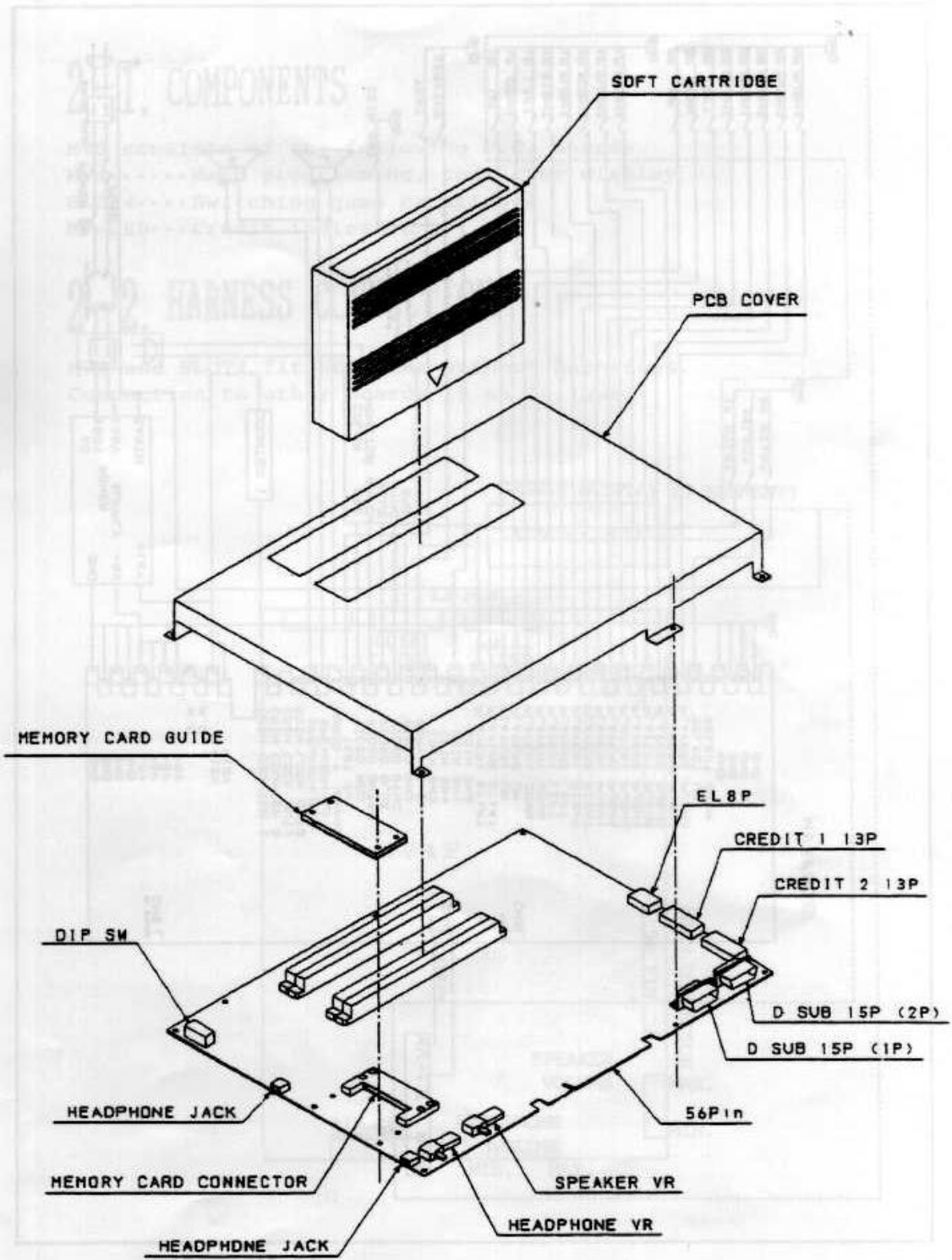

# 1-4. WIRING DIAGRAM

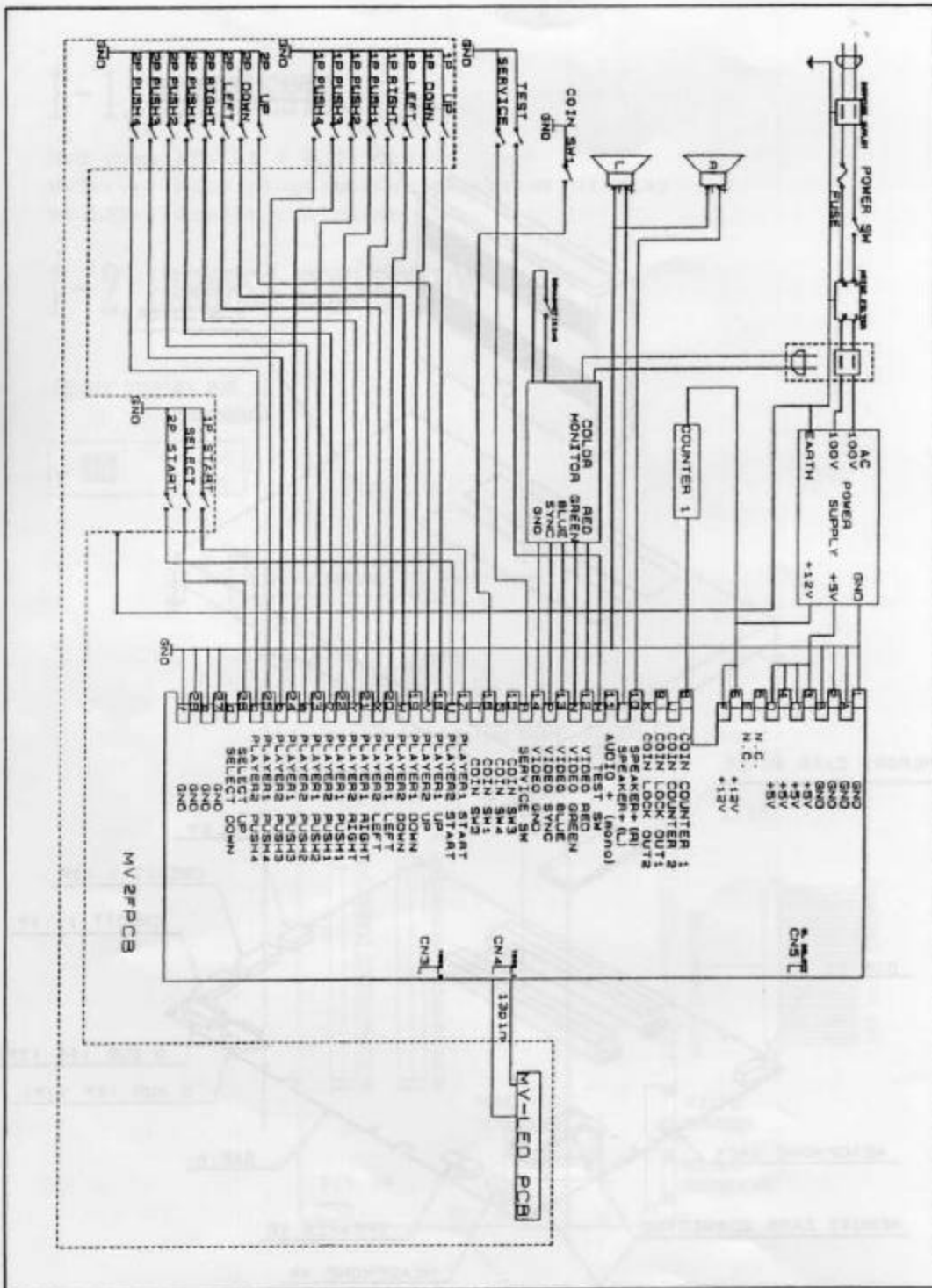

## 【2】MV-4

DIAGRAM

S-3 ASSEMBLY

### 2-1. COMPONENTS

MVS consists of the following P.C. boards.  
MV4.....Main programming, character display  
SLOT4....Switching game cartridges  
MV-LED...Credit indicator

### 2-2. HARNESS CONNECTION

MV4 and SLOT4 fit together without harnesses.  
Connection to other boards is as follows;

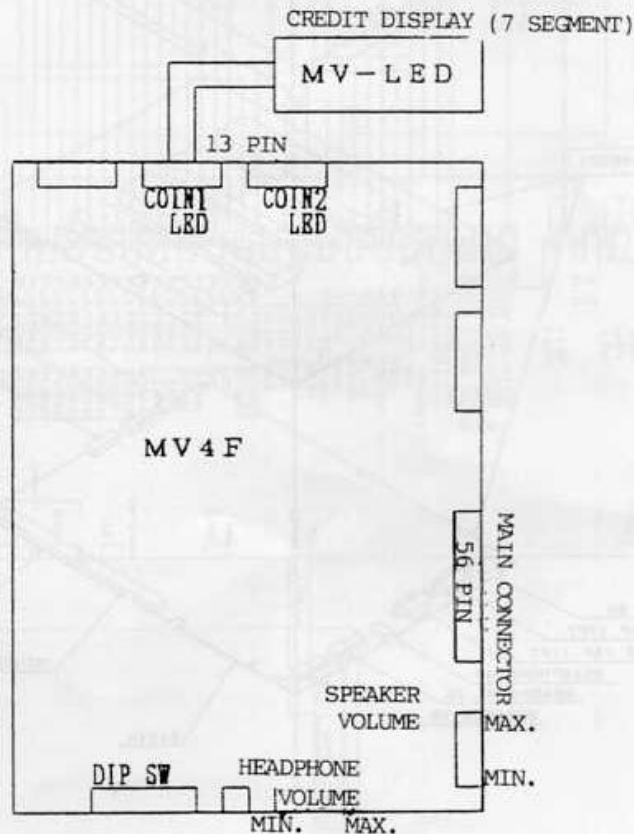



# 2-3. ASSEMBLY

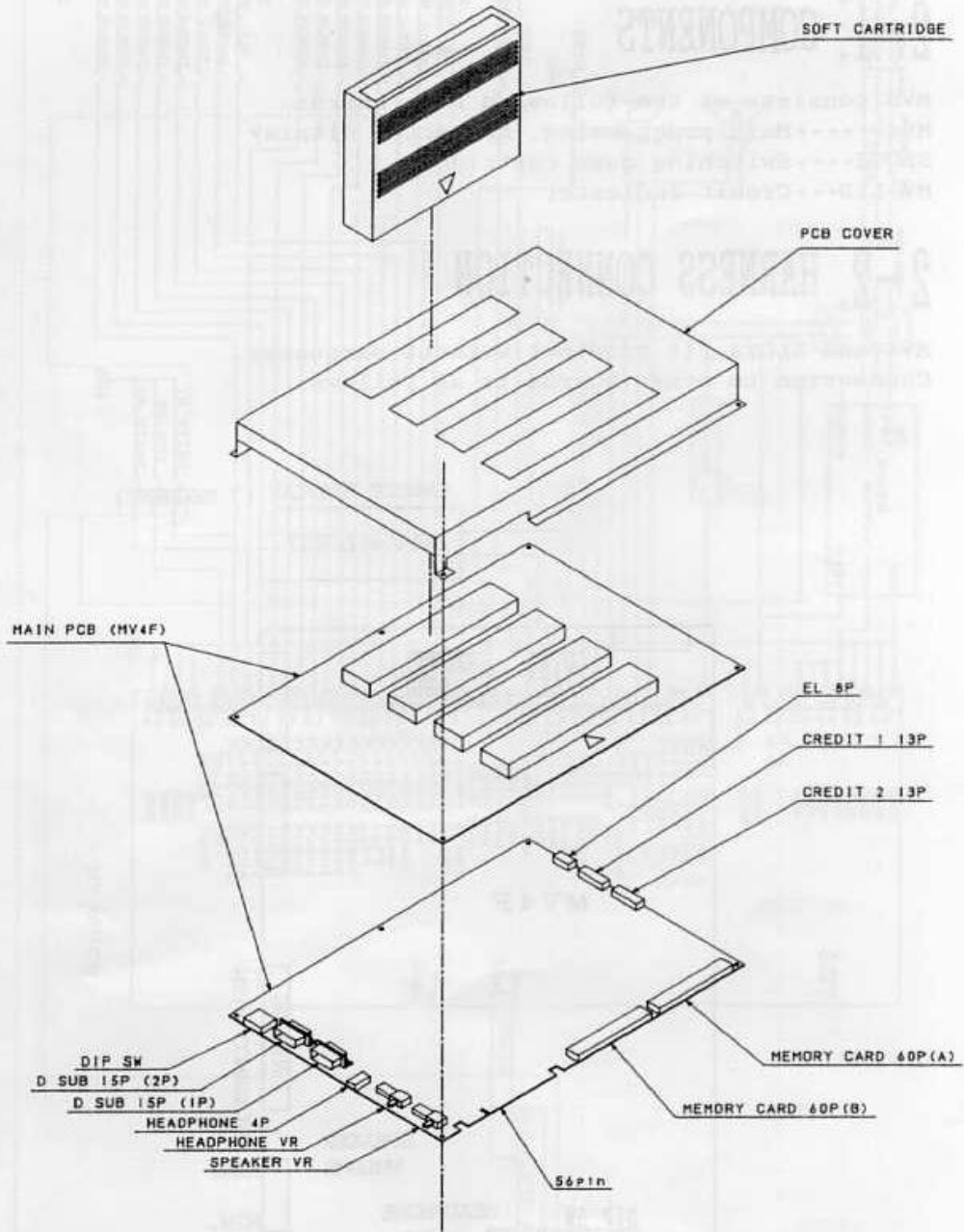





## [3] SETTING THE SOFT CARTRIDGES

### 3-1. BEFORE SETTING

Make sure that power is off when you insert or remove the cartridges. If power is not off, technical problems may occur.

### 3-2. SETTING CARTRIDGES

Make sure that the game cartridge is installed with the markings matching the main board, then insert it firmly.

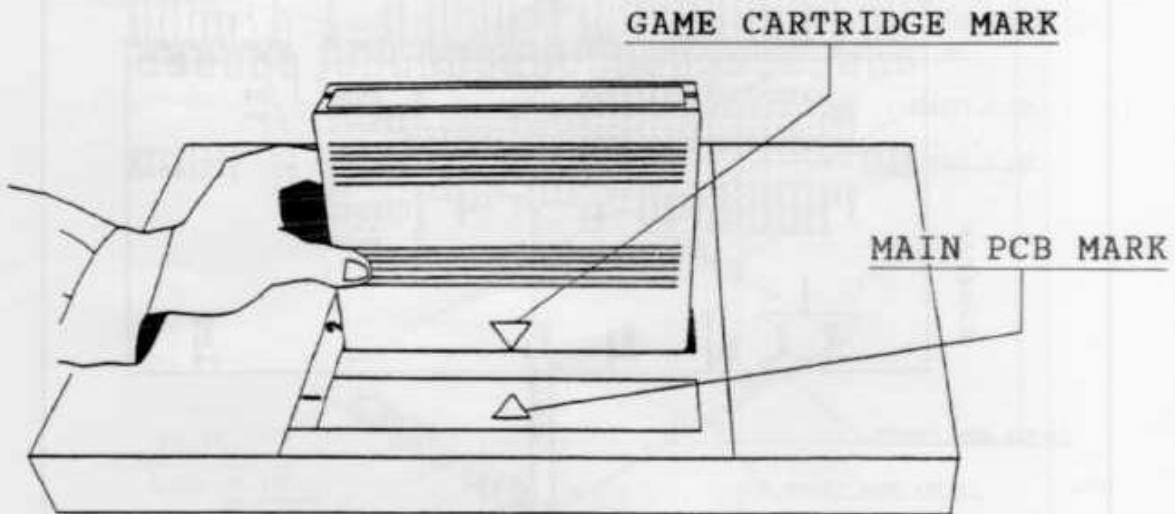

### 3-3. POWER ON

Turn the power on and gently wiggle the cartridge in the slot. If any abnormal sounds or graphics on the screen appear, turn off the power immediately and try the procedure again.

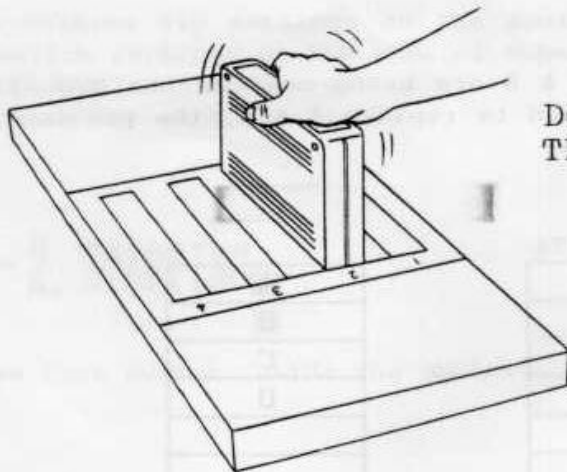

DO NOT WIGGLE  
THE CARTRIDGES HARD

### 3-4. UNUSED SLOTS

To keep the unused slots from collecting dust and things, protect the slots with the cover provided.

PROTECT THE UNUSED  
SLOTS WITH COVERS.

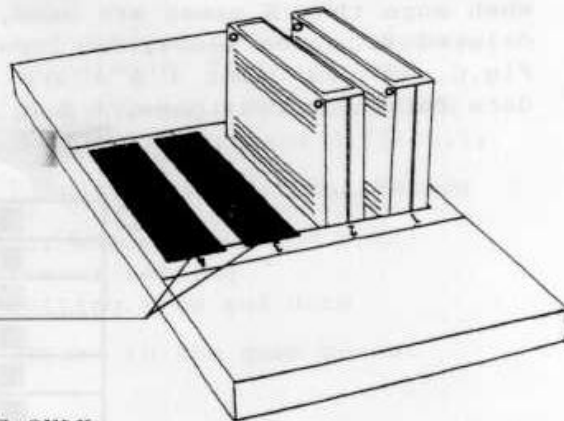

FIGURE OF MV-4, MV-2 HAS 2 SLOTS ONLY.

CAUTION: Do not insert any cartridge other than the MVS cartridge with the 240 pin connector. The NEO-GEO Home Use Cartridge will not fit on this connector.

## [4] INCOME DATA KEEPING SYSTEM

The MVS can keep income data of a maximum 8 games even when the power is off or the game cartridges are removed from the PCB.

For example: 2 games, A & B are being used on the MVS. If new game titles C & D are used to replace A & B, the previous data for A & B will remain.

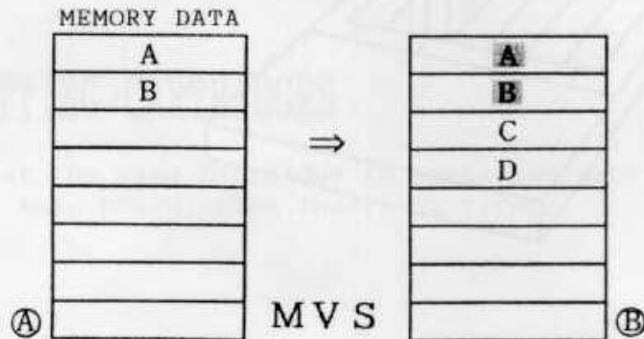

When the game cartridges, once removed, are set again later, new data will be added to the previous data.

When more than 8 games are used, the oldest game's data will be deleted from the memory to input data for newest game. In the Fig.C, if new games I & J are used to replace any games, the data for the oldest game, A & B, will be deleted.

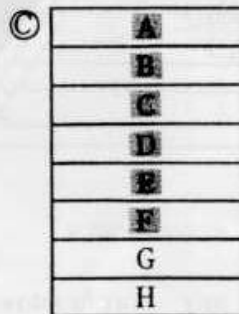

# 【5】TEST MODE

## 5-1. MODE SETTING

The MVS enables dip settings on the monitor screen instead of the dipswitch settings on the PCBs of other systems. Bookkeeping is also possible on the screen. Read further for each operation.

## 5-2. STARTING

Press the test switch inside the cabinet.

## 5-3. MAIN MENU

MAIN MENU

- |                            |   |  |
|----------------------------|---|--|
| ▶HARDWARE TEST             | : | For cabinet switches, monitor adjustment, EL board test. |
| SETTING UP THE HARD DIP    | : | Displays main PCB dipswitch                              |
| SETTING UP THE SOFT DIP    | : | Setting credit and difficulty                            |
| BOOK KEEPING               | : | Displays income totalization                             |
| SETTING UP THE CODE NUMBER | : | For memory card and code number setting                  |
| SETTING UP THE CALENDAR    | : | Setting time and date                                    |
| EXIT                       | : | Return to the game screen                                |

☞ Use the joystick to move the cursor on the screen and press the "A" button to confirm mode. Press "C" button to return to the previous menu.

# 5-4. HARDWARE TEST

## HARDWARE TEST

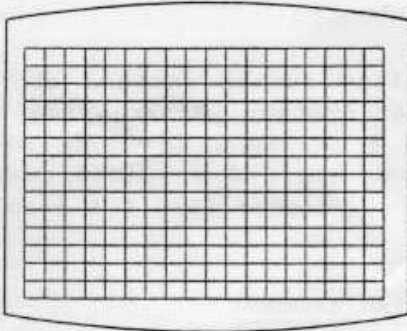

: Cross Hatch

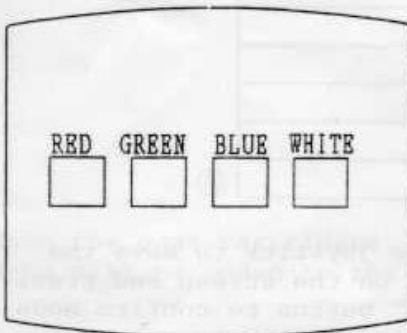

☑ Press the 1 player start button

☑ For adjusting color on the screen



I/O CHECK					
	P1	P2	12345678		
UP	0	0	00000000		
DOWN	0	0			
LEFT	0	0			
RIGHT	0	0	COIN1	0	
PUSH1	0	0	COIN2	0	
PUSH2	0	0	SERVICE	0	
PUSH3	0	0	TEST	0	
PUSH4	0	0	EL LED1	LED2	
START	0	0	0	00	00
SELECT	0	0			

☑ Press the 1 player start button

☑ "1" stands for "on" and "0" for "off" of the dipswitch.

☑ Check if the no. of LED1 is the same as the credit display. Disregard the display of LED2.

## 5-6. SETTING THE SOFTWARE DEP.

SETTING UP THE SET UP

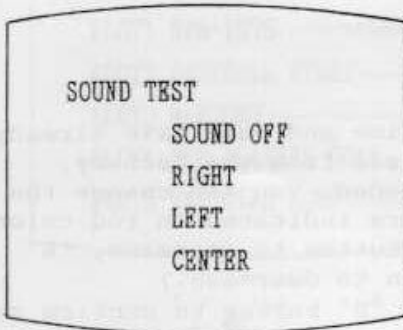

☞ Press the 1 player start button

☞ Move the joystick up and down to select type of the sound.  
RIGHT...right speaker is louder.  
LEFT...left speaker is louder.  
CENTER...in stereo



☞ Press the 1 player start button

☞ You can check if the memory card works properly by inserting it into the memory card slot.  
NOTE: Saved data on the card will be erased.

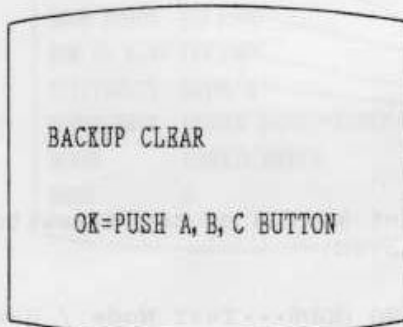

☞ Press the 1 player start button

☞ You can clear previous data (income data, etc.) by pressing A, B & C buttons at the same time.



## 5-4. HARDWARE TEST



☞ Press IP button to start

SETTING UP THE CALENDAR  
 CURRENT TIME  
 17/ 2/90 SAT  
 19:30:41  
 THE TIME TO BE SET UP  
 A BUTTON, JOYSTICK=SELECT  
 17/ 2/90 19:30:41

☞ The time and date have already been set from the factory. If needed, you can change the numbers indicated in red color. ("A" button to increase, "B" button to decrease.) Press "D" button to confirm setting.  
 NOTE: Calendar setting is not available right after the BACKUP CLEAR operation (see P.14) .

☞ Press IP button to start

RETURN TO CROSS HATCH

## 5-5. SETTING THE HARDWARE DIP

HARD DIP SETTING

SETTING UP THE HARD DIP  
 12345678  
 SETTING MODE 1..... ON  
 COMMUNICATION ...000.. OFF  
 FREE PLAY .....0. OFF  
 COIN SWITCH ..0..... 2  
 STOP MODE .....0 OFF  
 0-OFF 1-ON

☞ Present status of the dipswitch is displayed.

SETTING MODE...Test Mode / Game Mode  
 CONTROLLER.....Mah-jong Controller / Normal Controller  
 COMMUNICATION..Communication plays  
 FREE PLAY.....Game start without inserting coins.  
 STOP MODE.....Function to pause game

# 5-6. SETTING THE SOFTWARE DIP

## SETTING UP THE SOFT DIP

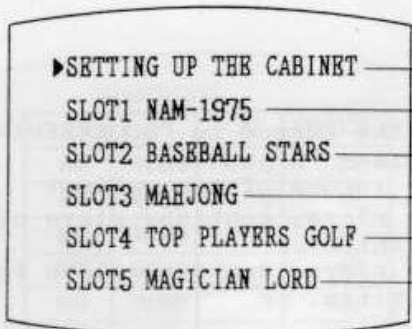

☞ Cabinet setting

☞ Software setting



## SETTING UP THE CABINET

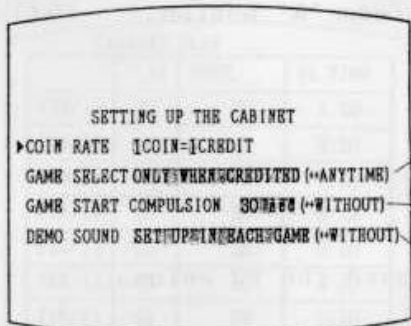

☞ Move the cursor to "CABINET SETTING" and press "A" button.

☞ Use the joystick to move the cursor for each setting.

☞ On "FREE PLAY", selection button works without credits. (Change mode with "A" button)

☞ Setting the time limit for game selection. (Increase time with "A" button, decrease with "B")

☞ "WITHOUT" is selected, no sound for any game. (Change mode with "A" button)



## SETTING UP THE SOFT DIP

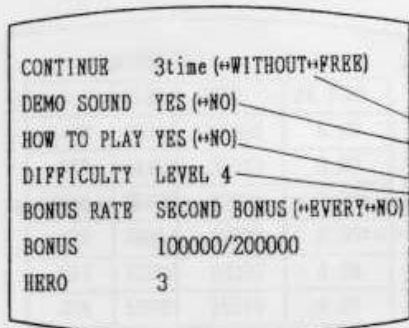

☞ Press "C" button to return to the previous menu. Move cursor to the game you wish to set and press "A" button.

☞ The screen shows example for NAM-1975. Some of the menu differs in other games.

☞ Setting the number of CONTINUE PLAYS.

☞ With or without demo sound.

☞ With or without "HOW TO PLAY" screen.

☞ Setting difficulty of the game. The higher the number, the more difficult the game.

☞ Press "C" button to confirm the setting and the SOFT DIP SETTING menu will appear again. Press "C" button once more to get to the Main menu.

# 5-7. BOOKKEEPING

## BOOK KEEPING

▶ CABINET/COIN
CABINET/PLAY
SLOT1 NAM1975
SLOT2 BASEBALL STARS
SLOT3 TOP PLAYERS GOLF
SLOT4 MAHJONG
SLOT5 MAGICIAN LORD

- ☞ Move the cursor to "BOOKKEEPING" and press "A" button.
- ; Total income of the cabinet
- ; Total plays, continue plays of the cabinet.
- ; Total plays, continue plays for each title.



## CABINET/COIN

CABINET/COIN			
	P1	P2	SERVICE
FEB/17	02244	0	25
FEB/16	04422	0	36
FEB/15	06633	0	47
FEB/14	08844	0	48
FEB/13	02399	0	29
FEB/12	05699	0	94

- ☞ Move the cursor to "CABINET/COIN" and press "A" button.

- ☞ Weekly income chart.
- Disregard the P2 column.



CABINET/COIN			
	P1	P2	SERVICE
JAN	42244	0	25
FEB	44422	0	36
MAR	56633	0	47
APR	68844	0	48
MAY	72399	0	129
JUN	55699	9	294

- ☞ Press "A" button

Income for the first 6 months of the year.



CABINET/COIN			
	P1	P2	SERVICE
JUL	42244	0	25
AUG	44422	0	36
SEP	56633	0	47
OCT	68844	0	48
NOV	72399	0	129
DEC	55699	0	294

Press "A" button

Income for the second 6 months of the year.

Press "C" button to return. Move the cursor to "CABINET/PLAY" and press "A" button.



CABINET/PLAY

CABINET/PLAY			
	PLAY	CONT.	AV. TIME
FEB/17	22	33	5:20
FEB/16	44	55	6:20
FEB/15	66	77	7:20
FEB/14	88	99	8:20
FEB/13	23	32	9:20
FEB/12	56	55	4:20
FEB/11	11	88	5:20

Press "A" button



CABINET/PLAY			
	PLAY	CONT.	AV. TIME
JAN	42244	33363	5:20
FEB	44422	35543	6:20
MAR	56633	37773	7:20
APR	68844	39983	8:20
MAY	72399	33232	9:20
JUN	55699	15519	4:20

Press "A" button

## 5-7. BOOKKEEPING

CABINET/PLAY			
	PLAY	CONT.	AV. TIME
JUL	42244	33363	5:20
AUG	44422	35543	6:20
SEP	56633	37773	7:20
OCT	68844	39983	8:20
NOV	72399	33232	9:20
DEC	55699	15519	4:20

☑ Press "A" button

☑ Retrieve the bookkeeping information for each title in the same way as "CABINET/COIN" and "CABINET/PLAY".

## SETTING UP THE CODE NUMBER

CODE NUMBER SETTING  
2408  
D BUTTON:SET  
CODE NUMBER WILL BE SET INTO  
#MEMORY CARD WHEN INSERTED  
DURING THIS MODE.

☑ Press "C" button twice to return to the Main menu. Move the cursor to "CODE NUMBER" and press "A" button.

☑ Move the cursor with the joystick. To change numbers, press "A" button to increase and "B" to decrease. The code number is set by pressing "D" button.

## 5-9. SETTING THE CALENDAR

To set the calendar, refer to 5-4, HARDWARE TEST.

## **【6】MAINTENANCE** Please note the following:

◇Voltage of the power supply should be A/C between 95 and 105.  
Note: A malfunction may occur if it exceeds the electrical capacity in the cases below;

\*If a machine is consuming a large capacity of electricity when connected to the same power supply as the cabinet.

\*If several cabinets were connected to the outlet on the backside of the cabinet.

◇When you turn the power on and the MVS will not work, check the status of the outlet, power supply and fuses.

◇Keep the Main PCB away from dust and other objects, it may cause a breakdown or damage to the PCB.

①If you cannot correct any malfunctions that may be occurring, contact the selling agency of the MVS for assistance.

②Do not try to repair the PCBs at users' side. Electric testers might damage the IC because of their internal voltage.

③When you send the defective PCBs to the agency, please mention the malfunction that is occurring.

④Be careful to pack them firmly for shipment.

# 【7】MAIN HARNESS

SOLDER SIDE	PIN #		PART SIDE
GND	A	1	GND
GND	B	2	GND
+5V	C	3	+5V
+5V	D	4	+5V
	E	5	
+12V	F	6	+12V
KEY	H	7	KEY
COIN COUNTER 2	J	8	COIN COUNTER 1
COIN LOCK OUT 2	K	9	COIN LOCK OUT 1
SPEAKER+ (L)	L	10	SPEAKER+ (R)
TEST SWITCH	M	11	AUDIO + (mono)
VIDEO GREEN	N	12	VIDEO RED
VIDEO SYNC	P	13	VIDEO BLUE
SERVICE SW	R	14	VIDEO GND
COIN SW 4 (PLAYER 2)	S	15	COIN SW 3 (PLAYER 1)
COIN SW 2 (PLAYER 2)	T	16	COIN SW 1 (PLAYER 1)
START 2	U	17	START 1
PLAYER 2 UP	V	18	PLAYER 1 UP
PLAYER 2 DOWN	W	19	PLAYER 1 DOWN
PLAYER 2 LEFT	X	20	PLAYER 1 LEFT
PLAYER 2 RIGHT	Y	21	PLAYER 1 RIGHT
PLAYER 2 PUSH 1	Z	22	PLAYER 1 PUSH 1
PLAYER 2 PUSH 2	a	23	PLAYER 1 PUSH 2
PLAYER 2 PUSH 3	b	24	PLAYER 1 PUSH 3
PLAYER 2 PUSH 4	c	25	PLAYER 1 PUSH 4
SELECT DOWN	d	26	SELECT UP
GND	e	27	GND
GND	f	28	GND