

CGA/EGA/VGA MONITOR

M31 SERIES (TOUCH SCREEN OPTIONAL)

USER'S MANUAL

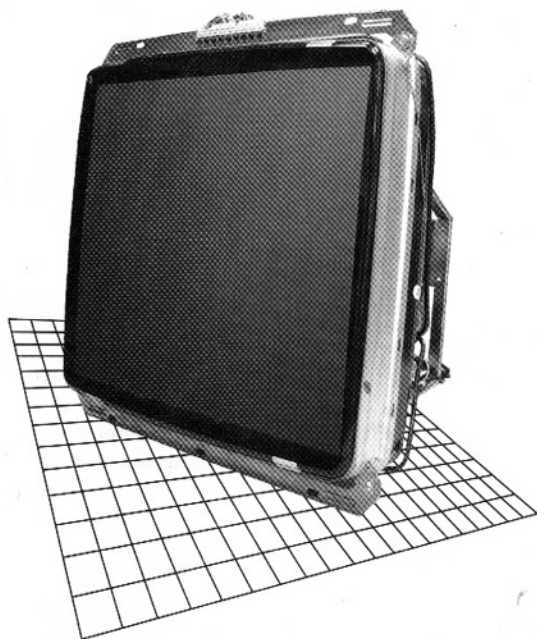



★ Primary side and Secondary side

The monitor's circuit which is divided into the primary side and secondary side, is insulated. Do not touch the primary side, or do not touch both the primary side and the secondary side simultaneously.

Not following the instruction can cause shock and this is very dangerous. When making monitor adjustments, use a non-conductive driver and make adjustment without touching any part other than the adjustment VR. Also, be sure not to cause a short-circuit to the primary side and secondary side.

If short-circuited, it may cause shock or malfunctioning, which is very dangerous.

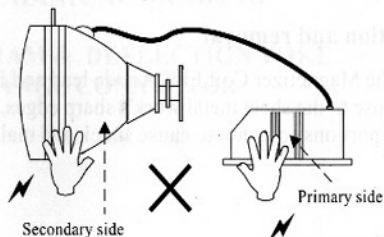

★ High Voltage

Some of the parts inside monitor are subject to high voltage in excess of 20,000 volts and very dangerous. Therefore, be sure not to touch the monitor interior.

Should soldering & paper wastes, etc. be mixed in the monitor interior, turn the power off so as not to cause malfunctioning or fire hazard.

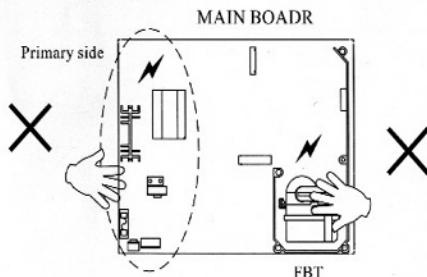



★ Connecting the CRT and PCB

For combining the CRT and PCB, use the specified part NO. to maintain the status of adjustments made at the factory. The anode of the CRT itself will be accumulatively charged as time elapses, generating high voltage which is very dangerous. the monitor should be used with the Chassis, CRT and PCB assembled. When repair, etc. is required at the time of malfunctioning, be sure to send it in an " as is assembled " condition. If these are disassembled, what's charged to said high voltage can be discharged, causing a very hazardous situation. Therefore, under no circumstances should it be disassembled.

★ Installation and removal

Ensure that the Magnetizer Coil, FBT, Anode lead and Focus lead are not positioned close to the sheet metal work's sharp edges, etc. and avoid damaging the insulated portions so as not to cause shock and malfunctioning.

★ Static Electricity

Touching the CRT surface sometimes causes you to slightly feel electricity. This is because the CRT surfaces are subject to static and will not adversely affect the human body.

INDEX

	PAGE
1. INTRODUCTION -----	1
2. CHECK LIST -----	1
3. INSTALLATION -----	2
4. ADJUSTMENT FUNCTIONS -----	3~6
5. SPECIFICATION -----	7
6. CHASSIS BASE MECHANICAL DRAWING -----	8
7. MONITOR MECHANICAL DRAWING -----	9~11
8. WIRING DIAGRAM & DEFLECTION YOKE POLARITY CHANGE CONNECTOR -----	12

1. INTRODUCTION

This high resolution monitor automatically scan horizontal frequency 15/24/31KHZ , and vertical frequency between 47 to 70 HZ , resolution 640x480 .

2. CHECK LIST

Please check the contents of the shipping carton. The color monitor contains the following items :

- ★ Monitor
- ★ Connector (Board)
- ★ Signal Wire
- ★ User's Manual

If any of above items is missing please contact your supplier as soon as possible. They should provide the missing parts to you.

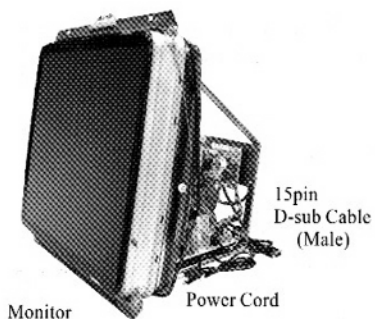

15pin D-sub Connector
(Female)

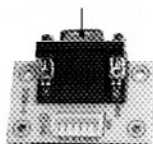

Connector(Board)



Signal Wire

3. INSTALLATION

Please make sure that the line voltage is exactly within the voltage range shown on the label .

Check if the signal source and this monitor are both turned off before connecting.

- ★ Plug the free end power cord into AC power source.
- ★ 15pin D-SUB cable connect to signal source. Fig 1 or Fig2

Fig1

PIN	VIDEO	PIN	VIDEO
1	R	13	H SYNC
2	G		C(H+V) SYNC
3	B	14	V SYNC
4,5,6,7,8,10,11	GND	9,12,15	No connection

15pin D-sub (Male)

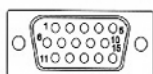

SIGNAL CABLE

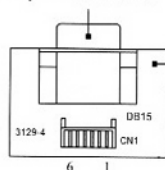

Fig2

SIGNAL WIRE



15pin D-sub / Female



- 1 V
- 2 C(H+V)
- 3 GND
- 4 B
- 5 G
- 6 R

STANDARD

Line / color	Video	Video
1 Grey	No connection	V SYNC
2 White	C(H+V) SYNC	H SYNC
3 Black	GND	GND
4 Blue	B	OR B
5 Green	G	→ G
6 Red	R	R



FOR SNK IC BOARD

Video
C(H+V) SYNC
C(H+V) SYNC
GND
B
G
R

SHORT

- ★ Turn on the signal source and monitor's power and can operate it.

REMARK : When start on the power supply of monitor or switch horizontal frequency, the situation for motion & voice of REALY is normal.

4. ADJUSTMENT FUNCTIONS

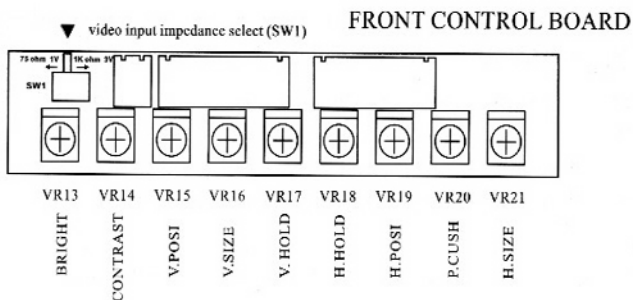

BRIGHT (VR13)

This adjust the on-screen image brightness.

CONTRAST (VR14)

This adjust the on-screen image contrast.

V.POSITION (VR15)

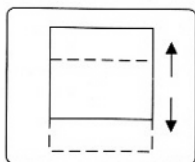

The image's vertical position is adjustable.

V.SIZE (VR16)

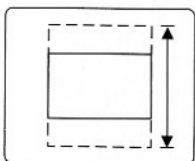

The vertical image dimensions are adjustable.

V.HOLD (VR17)

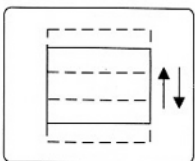

The on-screen image's vertical hold is adjustable.

H.HOLD (VR18)

FRONT CONTROL BOARD

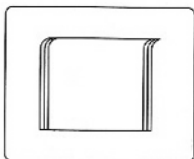

The on-screen image's horizontal hold is adjustable.

H.POSITION (VR19)

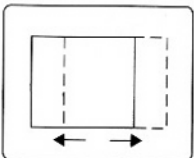

The image's horizontal position is adjustable.

PINCUSHION (VR20)

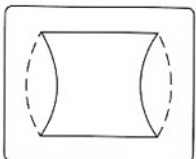

Control pincushion distortion.

H.SIZE (VR21)

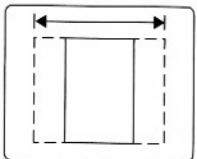

The horizontal image dimensions are adjustable.

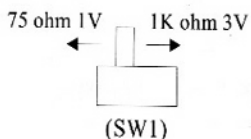

VIDEO IMPEDANCE SELECT

75 ohm : 31K PC GAME
SEGA(NAOMI) 15/31K GAME BOX -
(without video amplifier box)

1K ohm : 15/24K GAME
SEGA(NAOMI) 15/31K GAME BOX -
(with video amplifier box)

MAIN BOARD

"★" Default setting already, don't adjust.

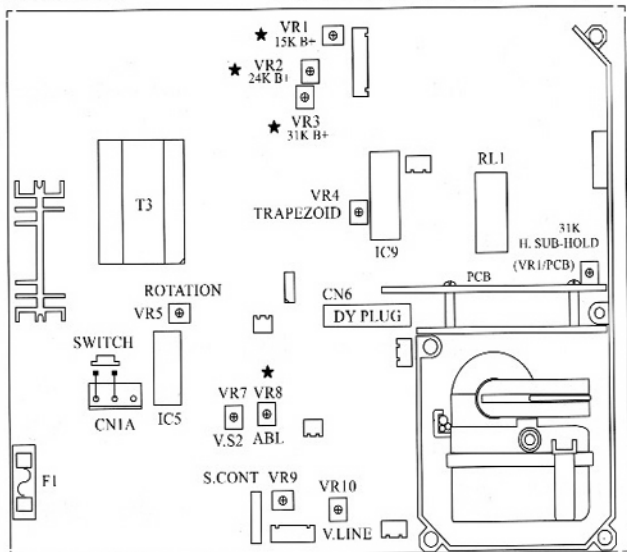

★ FOCUS 1/FOCUS 2/SCREEN (DOUBLE FOCUS)
FOCUS / SCREEN

DEGAUSSING(CN1A/SW)
(MANUAL / OPTIONAL)

Eliminates color unevenness from
the screen.

TRAPEZOID (VR4)

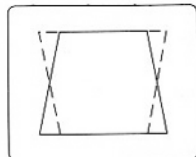

Control trapezoid distortion.

ROTATION (VR5) FOR 17"~38"

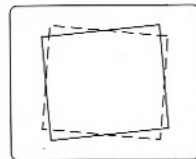

Adjust the evenness of screen image relative
to a horizontal line.

V.LINE (VR10)

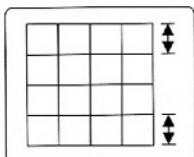

Control vertical linearity.

V. SUB-SIZE (VR7)

Adjust the vertical size of screen image.

S.CONT (VR9)

Adjust image contrast.

H. SUB-HOLD (VR1/PCB)

Adjust the horizontal hold of screen image. (for 31KHZ)

FOCUS

To be adjusted to the best status.

SCREEN

Adjust to the cut-off point.

CRT BOARD

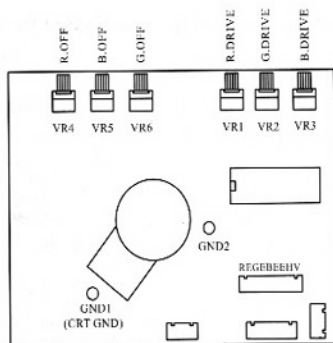

1. R DRIVE (VR1)

Turning this to the right will result in the red color becoming darker.

2. G DRIVE (VR2)

Turning this to the right will result in the green color becoming darker.

3. B DRIVE (VR3)

Turning this to the right will result in the blue color becoming darker.

4. R OFF (VR4)

Turning this to the right will result in the red color becoming darker.

5. B OFF (VR5)

Turning this to the right will result in the blue color becoming darker.

6. G OFF (VR6)

Turning this to the right will result in the green color becoming darker.

5. SPECIFICATION

1. H.FREQUENCY : 3-MODE (15/24/31KHZ) , AUTO
2. V.FREQUENCY : 47~70HZ
3. VIDEO INPUT : TTL 2.5~5.0Vpp / ANALOG (75ohm) 0.7Vpp
4. SYNC : TTL 2.5~5.0Vpp NEGATIVE / POSITIVE (SEPARATE OR COMPOSITE)
5. RESOLUTION & BANDWIDTH : 640X480 , 65MHZ
6. ADJUSTMENT FUNCTIONS :
BRIGHTNESS , CONTRAST , V.POSITION , V.SIZE , V.HOLD , V.LINE ,
H.HOLD , H.POSITION , PINCUSHION , H.SIZE , TRAPEZOID ,
ROTATION(17"~38") , R.G.B ADJ , VIDEO IMPEDANCE SW
7. EXTERNAL ADJUSTMENT FUNCTIONS :
BRIGHTNESS , CONTRAST , V.POSITION , V.SIZE , V.HOLD , H.HOLD
H.POSITION , PINCUSHION , H.SIZE , VIDEO IMPEDANCE SW
8. DEGAUSSING : STANDARD (AUTO) / MANUAL(OPTIONAL)
9. SIGNAL CONNECTOR : 15PIN D-SUB (MALE) , 6PIN(R,G,B,GND,H+V,V)
10. AC POWER : 100~240VAC , 50/60HZ
11. OPERATING TEMPERATURE 0~40°C , HUMIDITY 10~80%
12. DIMENSION / WEIGHT(without touch)

SIZE	DOT (mm)	POWER CONSUMPTION	FRAME TYPE	PACKING DIMENSION LxWxH (mm)	WEIGHT	LOADING(Q'TY)	
						20" CONTAINER	40" CONTAINER
14"	0.28	70W	1	470x450x340	12.3KG	420	875
15"	0.28	70W	1	475x465x360	14.1KG	360	750
17"	0.27	80W	1	495x490x385	17.2KG	288	576
19"	0.26	85W	1	524x536x422	21.7KG	220	440
20"	0.75 0.31	90W	1	580x570x455	22.8KG	200	420
21"	0.75	90W	2	555x540x500		176	384
25"	0.8	100W	2	620x580x620	28.0KG	108	228
29"	0.8	120W	2	635x575x715	38.5KG	108	216
29" DYNA	0.7	120W	2	715x635x580	46.6KG	108	216
34"	0.8	130W	2	800x715x610	57.5KG	63	135
38"	0.8	140W	2	890x780x655	69.5KG	54	117

Note. Frame type view monitor mechanical drawing

6. CHASSIS BASE MECHANICAL DRAWING

1: $\phi 3.5$
2: $\phi 4.4$

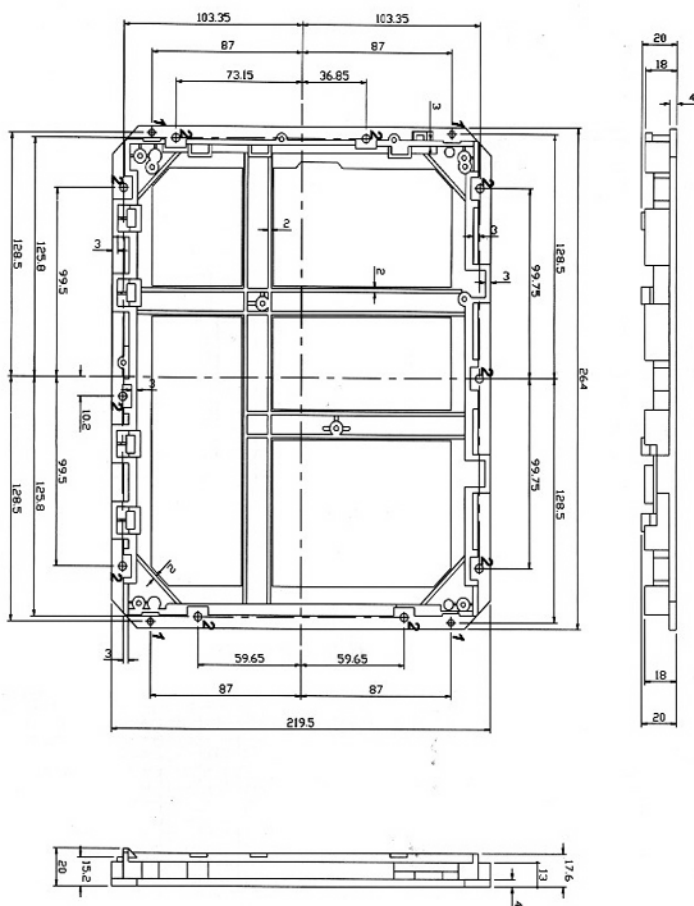

7. MONITOR MECHANICAL DRAWING

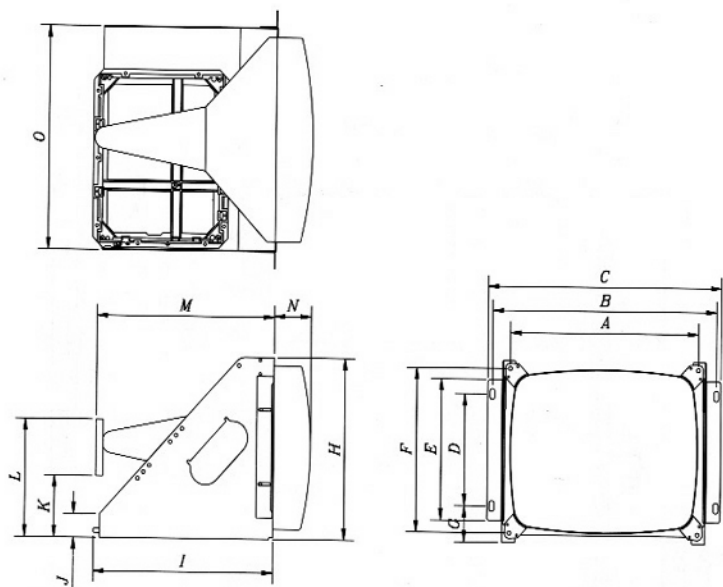

FRAME TYPE 1

Units: mm

MODEL	SIZE	A	B	C	D	E	F	G	H	I	J	K	L	M	N	O
M3114-21	14"	308	370	386	146	190	244	63	270	295	38	85	187	275	65	330
M3119-21	19"	408	457	472.5	224	267	323	57	341	375	48.8	115	238	427	40	425.5

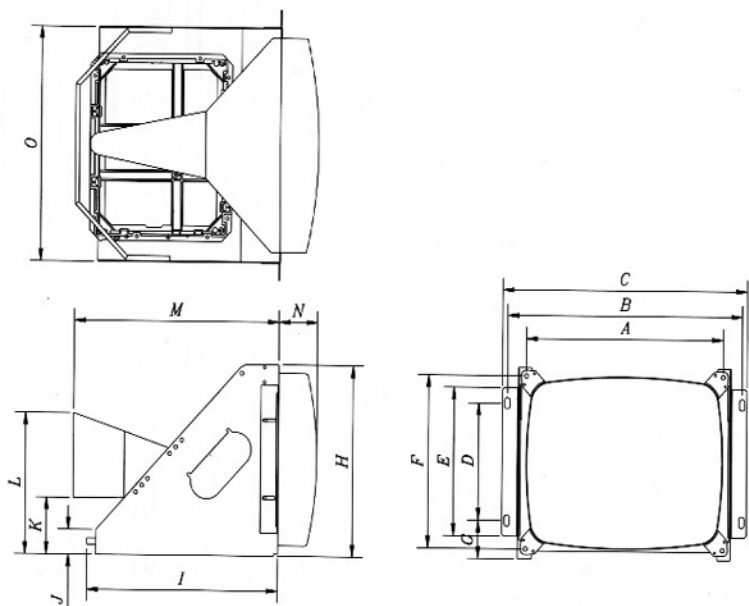

FRAME TYPE 1

Units: mm

MODEL	SIZE	A	B	C	D	E	F	G	H	I	J	K	L	M	N	O
M3117-21	17"	366	422.5	437	166	210	288	77	315	315	38	113	235	369	41	387
M3120-21	20"	427	495.5	511	226	270	337	69.5	363	323	38	129	250	380	80	465

FRAME TYPE 2

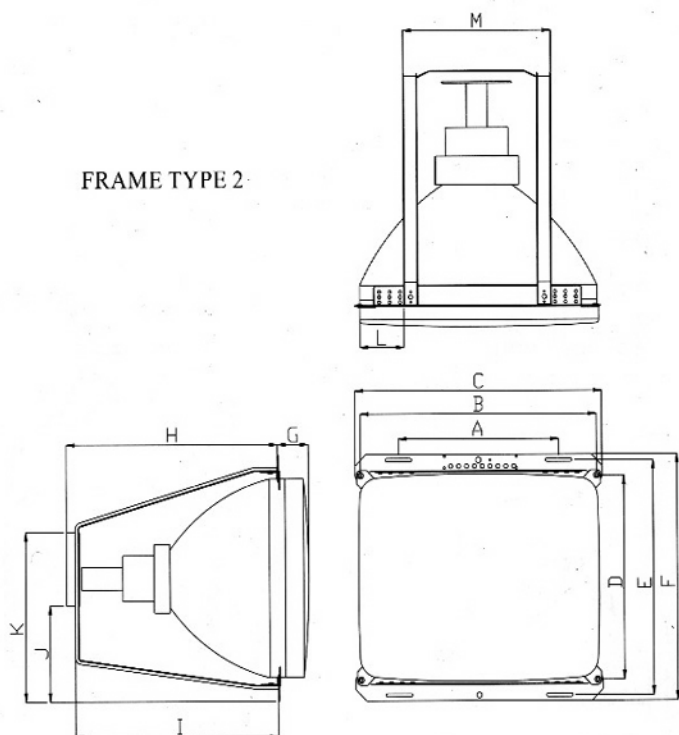

Units: mm

MODEL	SIZE	A	B	C	D	E	F	G	H	I	J	K	L	M
M3117-XX	17"													
M3119-XX	19"													
M3120-72	20"	295	433	456	335	395	410	75	390	384	150	270	98	254.5
M3121-72	21"	345	450	470	355	405	420	65	405	402	210	280	84	281
M3125-82	25"	354	525	555	408	462	480	60	392	358	200	272	90	320
M3129-82	29"	422.5	593	625	473	522.5	540	81	409	394	238	339	160	278
M3129D-72	29" DYNA	422.5	593	625	473	522.5	540	45	409	394	238	339	160	278
M3134-82	34"	632	690	723	543	605.7	634	103		446	271	369	166	320
M3138-82	38"	614	785	815	608	660	688	118	464	447	243	344	245.5	320

8. WIRING DIAGRAM & DEFLECTION YOKE POLARITY CHANGE CONNECTOR

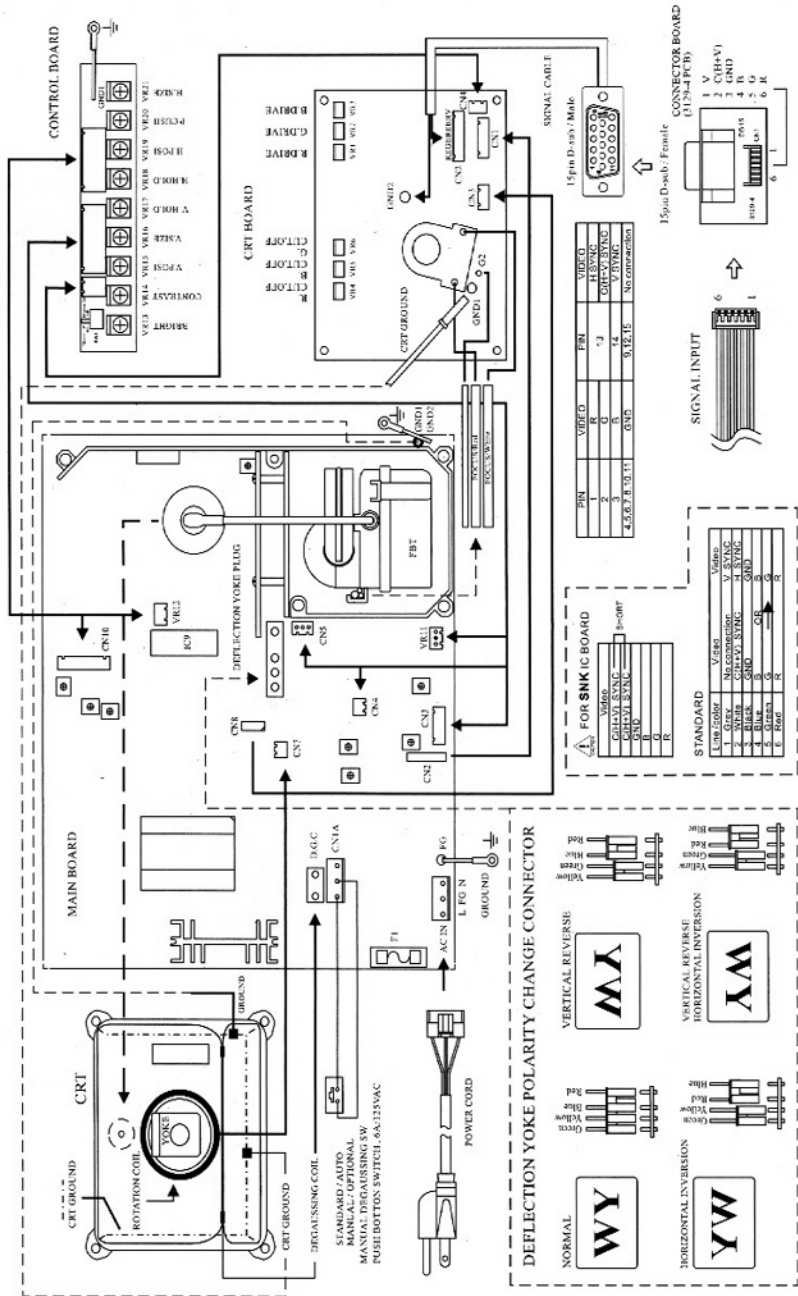



維亞

HUAI I ELECTRONICS CO., LTD.